

Diritti riservati All rights reserved

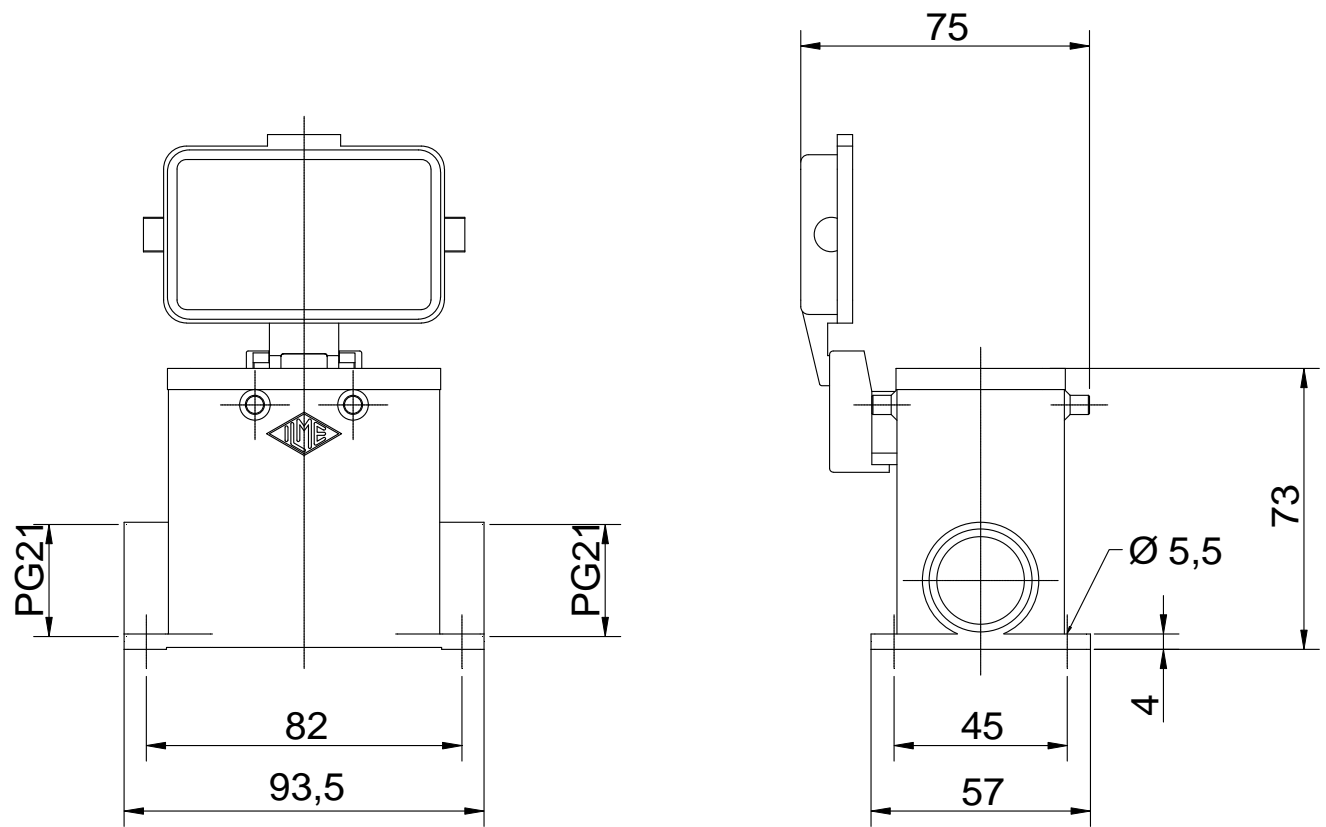

Date 04.01.2007	CMAP 03 CP2		Scale
Sign.	surface mount.h.pegs, cov.2xPG21 ins.		1:2
			